

Small Signal Schottky Diode

Features

- Integrated protection ring against static discharge
- Very low forward voltage
- AEC-Q101 qualified
- Compliant to RoHS directive 2002/95/EC and in accordance to WEEE 2002/96/EC
- Halogen-free according to IEC 61249-2-21 definition



RoHS
COMPLIANT
HALOGEN
FREE

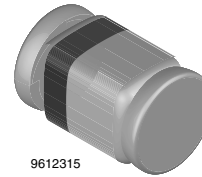

9612315

Applications

- Applications where a very low forward voltage is required

Mechanical Data

Case: MicroMELF

Weight: approx. 12 mg

Cathode band color: black

Packaging codes/options:

TR3/10 k per 13" reel (8 mm tape), 10 k/box

TR/2.5 k per 7" reel (8 mm tape), 12.5 k/box

Parts Table

Part	Type differentiation	Ordering code	Remarks
BAS386	$V_R = 50\text{ V}$	BAS386-TR3 or BAS386-TR	Tape and Reel

Absolute Maximum Ratings

$T_{amb} = 25\text{ }^\circ\text{C}$, unless otherwise specified

Parameter	Test condition	Symbol	Value	Unit
Reverse voltage		V_R	50	V
Peak forward surge current	$t_p = 10\text{ ms}$	I_{FSM}	5	A
Repetitive peak forward current	$t_p \leq 1\text{ s}$	I_{FRM}	500	mA
Forward continuous current		I_F	200	mA
Average forward current		I_{FAV}	200	mA

Thermal Characteristics

$T_{amb} = 25\text{ }^\circ\text{C}$, unless otherwise specified

Parameter	Test condition	Symbol	Value	Unit
Junction to ambient air	on PC board 50 mm x 50 mm x 1.6 mm	R_{thJA}	320	K/W
Junction temperature		T_j	125	$^\circ\text{C}$
Storage temperature range		T_{stg}	- 65 to + 150	$^\circ\text{C}$

Electrical Characteristics

$T_{amb} = 25\text{ }^{\circ}\text{C}$, unless otherwise specified

Parameter	Test condition	Symbol	Min.	Typ.	Max.	Unit
Forward voltage	$I_F = 0.1\text{ mA}$	V_F			300	mV
	$I_F = 1\text{ mA}$	V_F			380	mV
	$I_F = 10\text{ mA}$	V_F			450	mV
	$I_F = 30\text{ mA}$	V_F			600	mV
	$I_F = 100\text{ mA}$	V_F			900	mV
Reverse current	$V_R = 40\text{ V}$	I_R			5	μA
Diode capacitance	$V_R = 1\text{ V}, f = 1\text{ MHz}$	C_D			8	pF

Typical Characteristics

$T_{amb} = 25\text{ }^{\circ}\text{C}$, unless otherwise specified

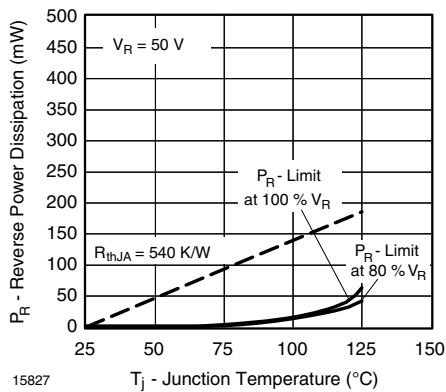

Figure 1. Max. Reverse Power Dissipation vs. Junction Temperature

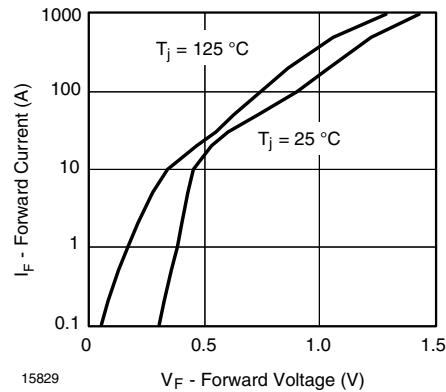

Figure 3. Forward Current vs. Forward Voltage

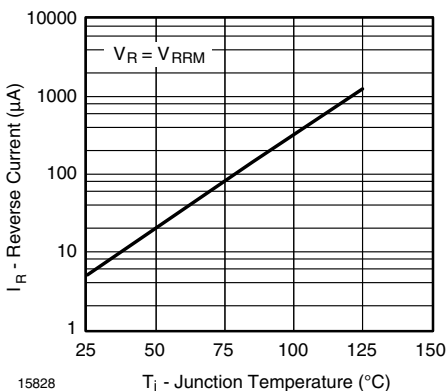

Figure 2. Reverse Current vs. Junction Temperature

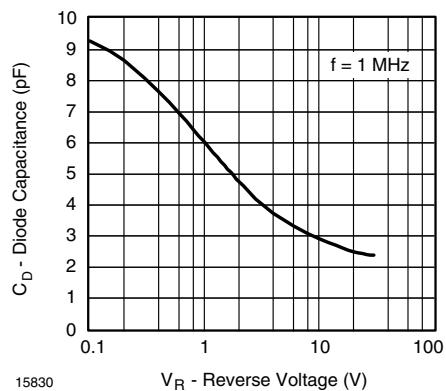

Figure 4. Diode Capacitance vs. Reverse Voltage

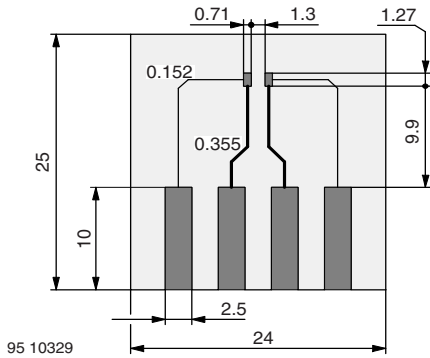
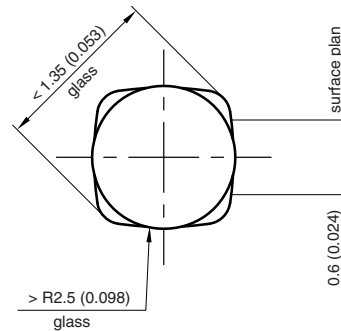
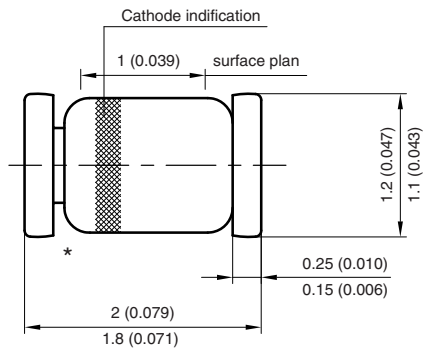

Figure 5. Board for R_{thJA} definition (in mm)

Package Dimensions in millimeters (inches): MicromELF



* The gap between plug and glass can be either on cathode or anode side

Foot print recommendation:

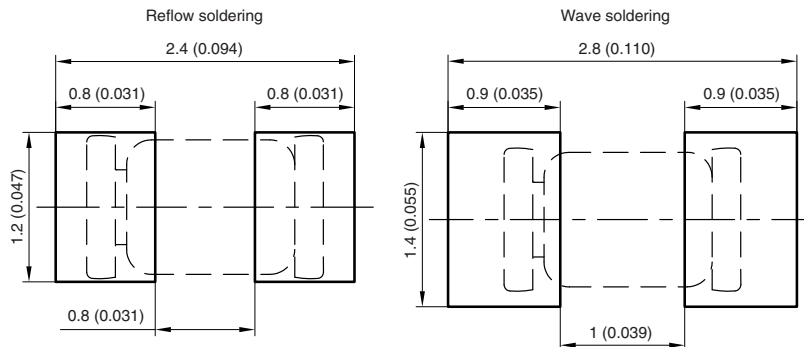

Created - Date: 26.July.1996
 Rev. 13 - Date: 07.June.2006
 Document no.: 6.560-5007.01-4
 96 12072



Disclaimer

All product specifications and data are subject to change without notice.

Vishay Intertechnology, Inc., its affiliates, agents, and employees, and all persons acting on its or their behalf (collectively, "Vishay"), disclaim any and all liability for any errors, inaccuracies or incompleteness contained herein or in any other disclosure relating to any product.

Vishay disclaims any and all liability arising out of the use or application of any product described herein or of any information provided herein to the maximum extent permitted by law. The product specifications do not expand or otherwise modify Vishay's terms and conditions of purchase, including but not limited to the warranty expressed therein, which apply to these products.

No license, express or implied, by estoppel or otherwise, to any intellectual property rights is granted by this document or by any conduct of Vishay.

The products shown herein are not designed for use in medical, life-saving, or life-sustaining applications unless otherwise expressly indicated. Customers using or selling Vishay products not expressly indicated for use in such applications do so entirely at their own risk and agree to fully indemnify Vishay for any damages arising or resulting from such use or sale. Please contact authorized Vishay personnel to obtain written terms and conditions regarding products designed for such applications.

Product names and markings noted herein may be trademarks of their respective owners.